

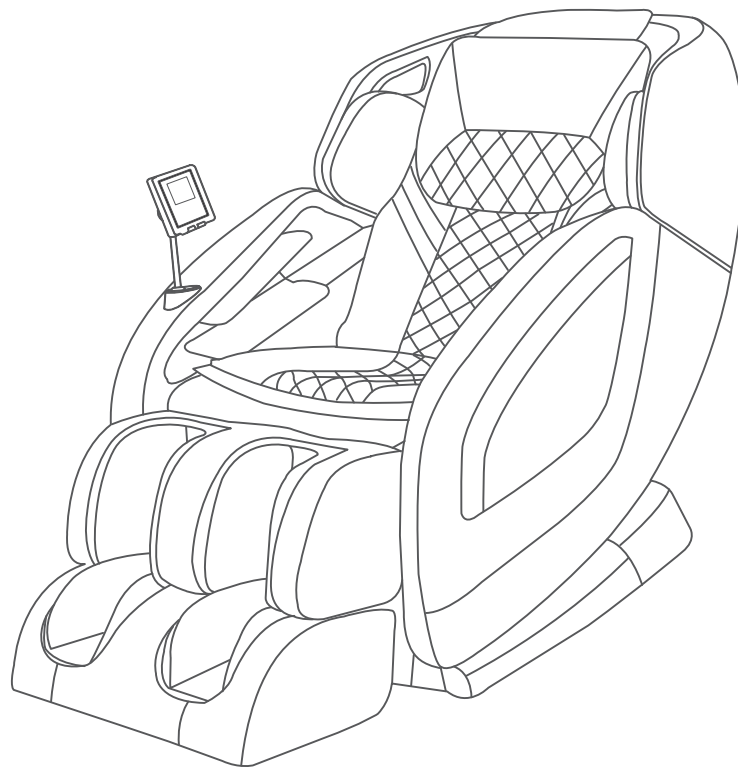

# ***SONIC-X***



Rev.1.0

User Manual  
OG 5572

# CONTENTS

Safety Instructions	03
Warranty Claims	05
Product Parts	06
Moving the Chair	07
Controller Diagram	08
Product Operation Guide	09
Product Features	26
Cleaning And Maintenance	27
Questions And Answers(Q&A)	28
Troubleshooting	29
Product Specification	31
Contact Us	32

# Safety Instructions

## Warning!

The plug must be fully inserted into an appropriate outlet. Improper connection of the equipment-grounding conductor can result in the risk of electric shock.

Check with a qualified electrician and service personnel if you are in doubt as to whether the product is properly grounded. Do not modify the product's accompanying plug. If the outlet is not suitable, be sure to have a proper outlet installed by a qualified electrician.



When using the massage chair, basic precautions should always be followed to reduce the risk of electric shock, burns, fire, or injury.

Read the following details before use:

1. Be sure to insert the massage chair plug into the proper electrical outlet.
2. Make sure that the power plug is securely inserted into the proper electrical outlet to reduce the risk of short-circuit and fire.
3. Always unplug the massage chair from the electrical outlet immediately after use and before cleaning.
4. DO NOT use the massage chair in places where the humidity is high.
5. DO NOT use the massage chair outdoors and avoid places with direct sunlight.
6. If the power goes off during use, be sure to turn the power switch to the OFF position and pull the power plug out from the socket to prevent any damages when the power comes back.
7. Never operate the massage chair if the power cord is wet or damaged.
8. Never plug/unplug the power cord from the socket with wet hands.
9. Close and continuous supervision is necessary when this appliance is used by or near children, invalids or disabled persons.
10. Use this appliance only as described in this user manual.
11. Do not use any attachments other than those recommended by OGAWA.
12. Do not stand, sit or jump in the calves rest when the massage chair is in use. This may result in an accident or injury.
13. Do not attempt to stand on the backrest and armrest .This may result in an accident or injury.
14. Be careful not to fall asleep during the massage.

## Safety Instructions

15. Always keep the massage chair clean and never insert any object into the gaps on and around the massage chair.
16. Do not remove the massage chair by pulling the power supply cord.
17. Be sure to check that there is no one (children in particular), pets or obstacles under the massage chair prior to lowering the leg rest /backrest.
18. Always check whether the surface of the massage chair is torn or ripped before use. If you find any unfamiliar tears in any area of the cloth in the backrest, do not use the massage chair. Kindly contact OGAWA service center immediately for repairs.
19. This appliance is designed for household use only.
20. For those suffering from illnesses, please consult your doctor on whether you can use the massage chair if in doubt.
21. The following persons are requested to consult a doctor prior to use in order to reduce the risk of the user feeling sick or suffering from an injury:
  - Those who have a malignant tumor;
  - Those who suffer from heart disease;
  - Those who are experiencing pregnancy, menstruation and puerperal;
  - Those who require complete rest;
  - Those who are under medical treatment;
  - Those who suffer from back problems or whose backbone is abnormal or bent.
22. If you experience pain during use, stop the massage chair immediately. If any injuries happen, consult a doctor immediately. Never massage on swollen or inflamed parts of the body.
23. This product is a non-professional appliance designed to provide a comfortable massage. Do not use this product as a substitute for medical treatment.
24. Do not use this massage chair for more than 30 minutes at one time and kindly limit the massage to a concentrated area for not more than 15 minutes. Over-massaging can result in overheating, and thus reducing the product's lifespan.
25. Do not operate where aerosol (spray) products are used or where oxygen is being administered.
26. Children shall not play with the appliance.  
Cleaning and user maintenance shall not be made by children without supervision.

- 
- 
- 
27. If the power plug is damaged, it must be replaced by a special plug available from OGAWA or authorized agents.
  28. As a safety precaution , Motor will stop working automatically (for protection) if apply too strong external force during use. Once appear above, switch OFF power ,and switch ON again after 10 seconds . Please pay attention to this ,especially for user whose weight over 100KG.
  29. The appliance has a heated surface. Persons insensitive to heat must be careful when using the appliance.
  30. This appliance can be used by children aged from 8 years and above and persons with reduced physical, sensory or mental capabilities or lack of experience and knowledge if they have been given supervision or instruction concerning use of the appliance in a safe way and understand the hazards involved



## Warranty Claims



1. Warranty is not transferable.
2. This warranty is effective only if the product is purchased from OGAWA.
3. Proof of purchase (original receipt) is required for all warranty repairs.
4. All implied warranties, including but not limited to these implied warranties of fitness and merchantability, are limited to the duration stated in the warranty policy.
5. Damage due to misuse, improper treatment and unauthorized modification and repair are not covered by this warranty.
6. Warranty does not cover accessories and attachments which do not belong to the massage unit.
7. Warranty is not effective to rental, business, commercial, institutional or other non-residential users.
8. All services covered by this warranty must be approved by OGAWA and repaired by authorized technicians only.
9. If replacement parts for defective materials are not available, OGAWA reserves the right to make substitution in lieu of repair or replacement.

# Product Parts

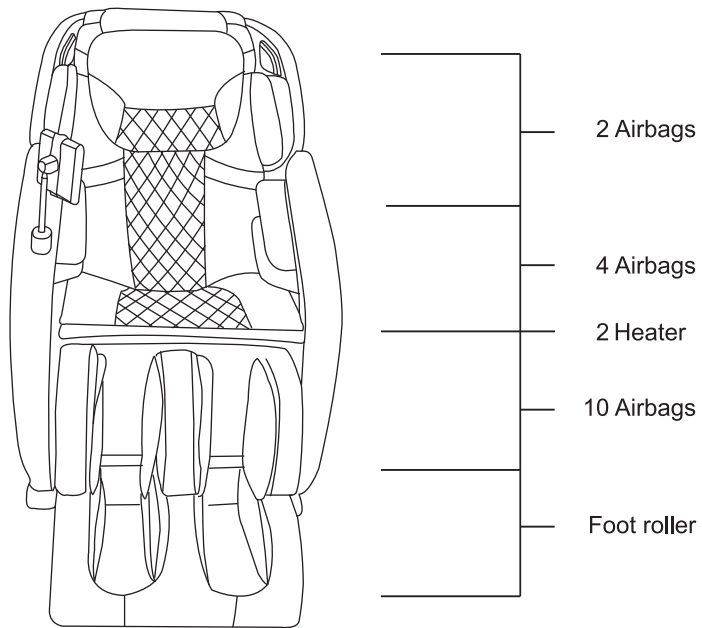
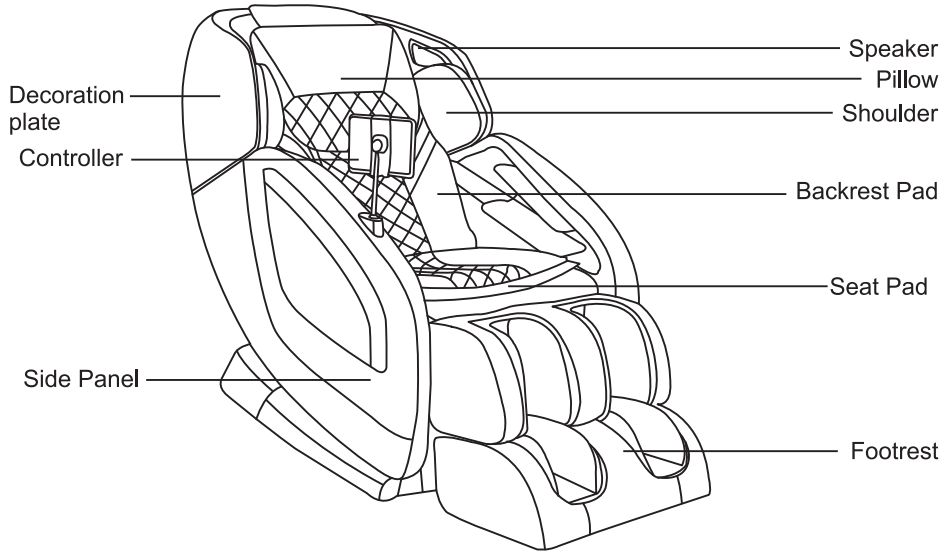

Important-product image or content descriptions may slightly differ due to product quality improvement.

## Moving the Chair

Press down the backrest, before reclining the chair to approximate 45° to easily move the chair around the house with a slight pull or push.

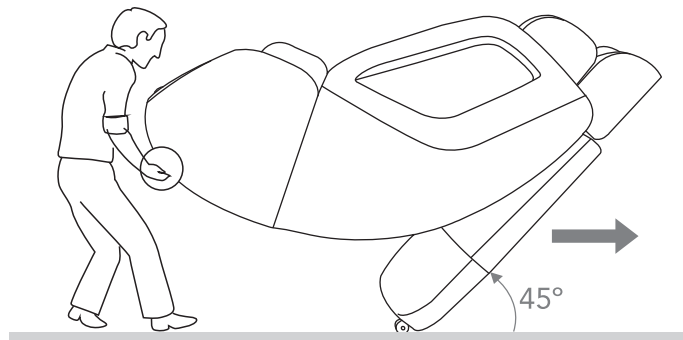
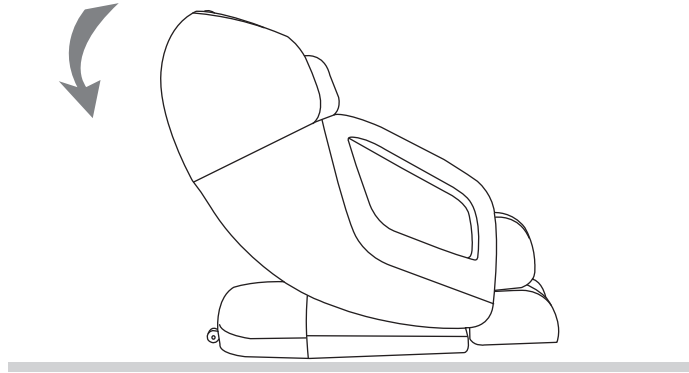

**Caution:**

- i. Before moving the chair, please put the footrest back in the original position. Otherwise, injuries might occur in the process of moving the chair.
- ii. Avoid moving the massage chair when there is someone seated on it.
- iii. Placing a mat underneath the massage chair is advisable, as the moving process might leave scratches on the floor surface.

## Controller Diagram

Always press the Power Button to start massage.









**Warning:** Only rated supply 220V must be used to avoid damage to electronic elements.



# Product Operation Guide

## TABLET CONTROLLER INSTRUCTIONS

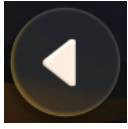
### 1. BASIC KEYS

KEYS	DESCRIPTION	GUIDELINES
	Off	Touch to stop massage and shut off the screen.
	Home	Touch to return to the home page.
	PAUSE	Touch once to halt current massage and countdown timer.
	RESTART	Touch to resume previous massage functions, as well as countdown timer.
	BACK	Touch to return to the previous page.
	ADJUSTMENTS	Touch to <b>ADJUSTMENTS</b> page.
	Air Massager	Touch to <b>AIR MASSAGER</b> page.

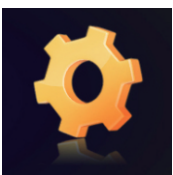

## 2. HOME PAGE MENU



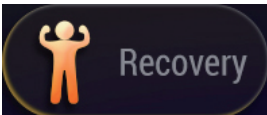
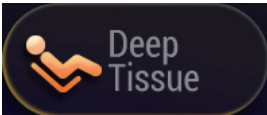

KEYS	DESCRIPTION	GUIDELINES
 <p><b>AUTO</b></p>	Auto	Touch to choose from 12 <b>AUTO</b> massage programs. <b>Work Relief, Recovery, Deep Tissue, Rest&amp;Sleep, Thai, Gentle, Athletic, Vertebral, For Her, For Him, Neck &amp; Shoulders, Waist&amp;Hip.</b>
 <p><b>MANUAL</b></p>	Manual	Touch to go to the <b>MANUAL</b> massage programs page, choose your preferred massage functions at desired intensities, fully customize your massage.
 <p><b>ADJUSTMENTS</b></p>	Adjustments	Touch to go to the <b>ADJUSTMENTS</b> page for zero gravity and massage intensities.
 <p><b>SETTINGS</b></p>	Settings	Touch to go to the system <b>SETTINGS</b> page for timer and other preferences.

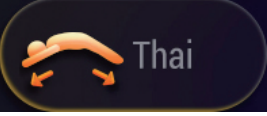
### 3. AUTO MASSAGE PROGRAMS



KEYS		GUIDELINES
	Work Relief	This is an exclusive massage program for the workplace, according to the features of long time desk work and business trip, it can ease muscles and recuperate body.
	Recovery	A full body deep massage includes Shiatsu, Knocking and Tapping to ease and relax muscles after surgeries.
	Deep Massage	A full body deep massage includes Shiatsu, Knocking and Tapping to ease and relax muscles after intense exercise, especially promote the body circulation system to improve the muscle recovery after exercise.

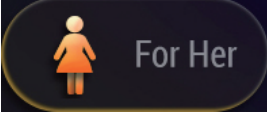

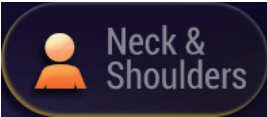
	<p>Rest &amp; Sleep</p>	<p>A program designed to provide a mild massage that is great for deep relaxation. This is the program to help improve the quality of lunch break and sleep. The mild massage kneads body parts from heavy strength to light one, from light to no strength to help soothe tired body gradually.</p> <p>Product features front and rear swing function that takes you into the fantasy space swinging state and a thorough relaxation, best used before going to sleep.</p>
	<p>Thai Stretch</p>	<p>This massage will stretch your calf muscles and hamstrings with a combination of gentle tapping, kneading, rolling, and air compression.</p> <p>This massage is inspired from Thai Massage, the strong kneading and stretch of the body can effectively stretch legs, it's the best choice to relax tired muscles and increase physical vigor.</p>
	<p>Gentle</p>	<p>A full body gentle massage includes Kneading and Heating, designed for daily use.</p>

	<p>For Athletics</p>	<p>An auto programme generated by the system, focus on the tension points collected from athletics, especially promote the body circulation system to improve the muscle recovery after exercise.</p>
	<p>Full Back Massage</p>	<p>A full body massage, mainly focus on your full back with a deep massage that includes air compression to relieve the symptoms of lumbar spine pain.</p>
	<p>For Her</p>	<p>A full body gentle massage includes Kneading and Heating, specially designed for female.</p>
	<p>For Him</p>	<p>A full body strong massage includes Kneading, specially designed for the male.</p>
	<p>Neck &amp; Shoulders</p>	<p>A full body massage, mainly focus on your neck and shoulders with a slow massage that incorporates soothing heat to relieve neck and back pain symptom. The curve design of the chair backrest makes the massage rollers completely fit the shoulders and the neck, which can effectively relieve fatigue and stiffness.</p>

	<p>Lower Back, Waist and Hips</p>	<p>A full body massage, mainly focus on your lower back, waist and hips with a deep massage that includes air compression to relieve full body pain.</p>
---	-----------------------------------	--

### Backrest Scanning Instructions

A body scan is performed every time the power is on and the user selects an Auto Mode, it is designed to ensure an accurate and personalized massage for every individual. After the power is on, sit on the chair slowly with your back against the chair back, your head against the pillow so the massage sensors can detect your Shoulder Height and the whole back position.

The Tablet Control gives beep sounds when completing a body scan. When micro-adjustment is needed, just touch Roller up/down   , then  to start massage. Make sure the body scan is finished correctly for the best massage.

Once body scan is completed, it will skip to the massage status page without further actions.

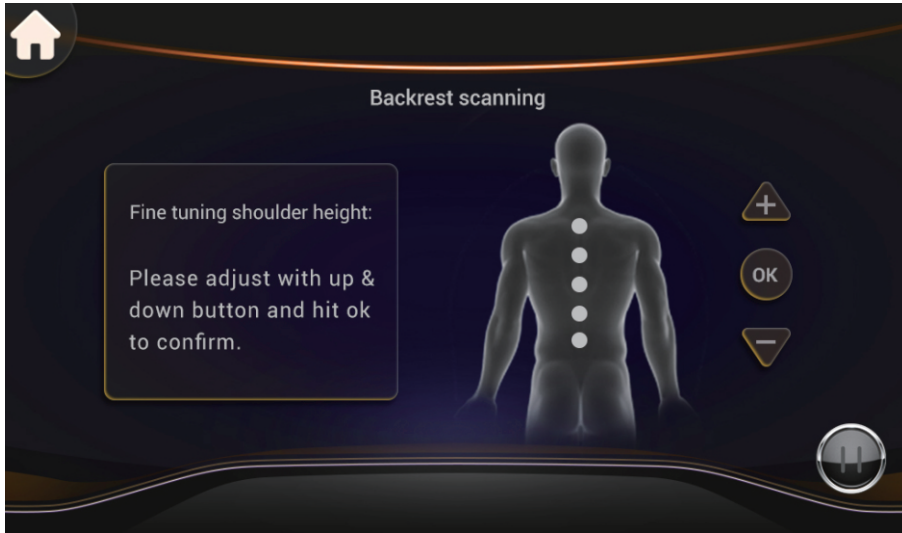

**Note:**

Heating, foot rollers and anion can be turned on/off manually during any auto mode, see below.

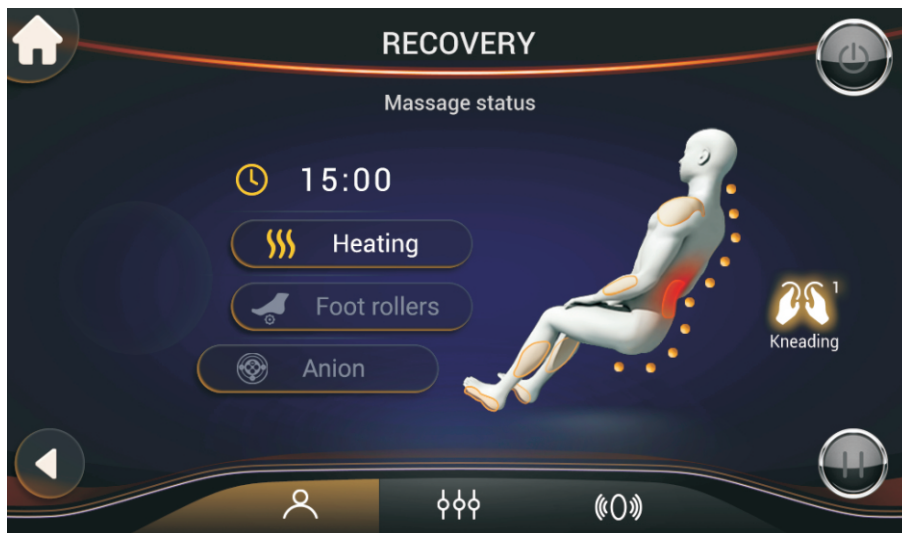

## 4. MANUAL MASSAGE PROGRAMS







6\*2 massage functions on demand.

**Kneading, Shiatsu, Swedish, Knocking, Tapping, Rolling.**

- Touch to choose a manual massage function for a full back massage at medium strength.
- Manual setting modes can not be combined with other modes.
- The default setting is spot-specific massage with medium width.
- Speed and width are adjustable by touching relative keys.





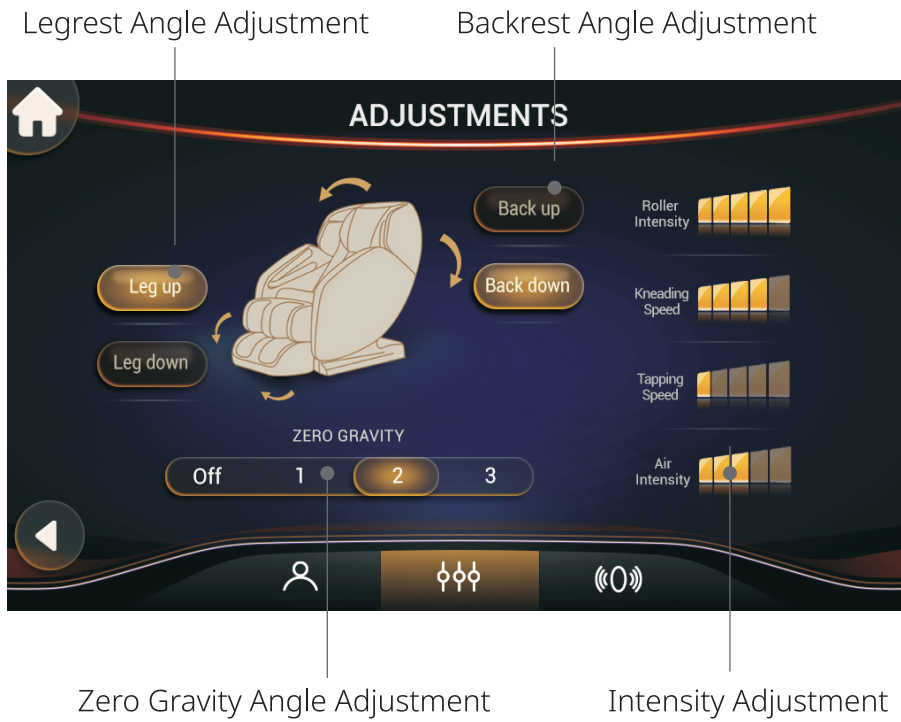

KEYS	DESCRIPTION	GUIDELINES
 Spot  Partial	Roller Spot/ Partial Massage	Touch Spot to activate localized Spot Massage while the original massage mode continues to run at the latest position.  Touch Partial to activate Partial Massage, rollers take the latest massage spot position as the center, and will travel approximately 3 inches up or down. Only effective under manual massage mode.
 Full	Full Back Roller	Full Back Massage.
 Width	Roller Width	Every touch will change the massage width interval in the sequence of WIDE>MEDIUM>NARROW. Only effective under manual massage mode.
 	Roller Up or Down	Up or down adjustment.

## 5. ADJUSTMENTS





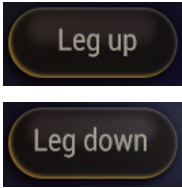
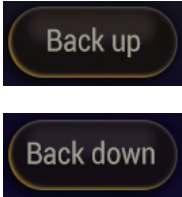

Zero-gravity is based on the NASA space capsule relaxation theory. Using the back, seat, and the leg rest, the chair puts the heart and knee at the same level, reducing the blood circulation pressure. Not only that, but all the gravitational forces can be dispersed to the massage chair, reducing heart and spine pressure.

## Zero Gravity Angle Adjustment

KEYS	DESCRIPTION	GUIDELINES
	<p>Angle Adjustment Key for Legrest</p>	<p><b>Leg Up</b> Long-press this button, the legrest will move up to the top position, release this button, legrest stops moving.</p> <p><b>Leg Down</b> Long-press this button, the legrest will move down to the lowest position, release this button, legrest stops moving.</p>
	<p>Angle Adjustment Button for Backrest</p>	<p><b>Back Up</b> Long-press this button, the backrest will move up to the original position, release this button, backrest stops moving.</p> <p><b>Back down</b> Long-press this button, the backrest will move down to the lowest position, release this button, backrest stops moving.</p>
	<p>Zero Gravity Function Control</p>	<p>Touch this button to activate the zero gravity position, and choose from Zero Gravity mode 1, Zero Gravity mode 2 and Zero Gravity mode 3.</p>

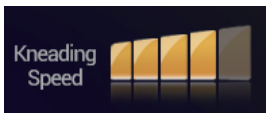
## Other Adjustments

KEYS	DESCRIPTION	GUIDELINES
	Roller Intensity	<b>SLOW / MEDIUM / FAST</b> Only effective under manual massage mode. 
	Kneading Speed	5 levels kneading speed adjustments.
	Tapping Speed	5 levels tapping speed adjustments.
	Air Intensity	5 levels tapping air intensity adjustments.

## 6. SETTINGS

Display Brightness  
Adjustment Bar

Side Panel Light  
On/Off



Message Timer

Engineering Mode

**Note:**

Engineering Mode is for Titan home service team use only.

## BLUETOOTH INSTRUCTIONS

Play Mobile Music/Bluetooth speaker:

Turn on Bluetooth of mobile, then select Bluetooth device of massage chair (OG5572). Once paired, it can act as speaker when mobile phone is playing music. (Remarks: No Password)

## AI VOICE ORDERS

Items	Function	Order	Response
1	ON/OFF	Hello, Massage	I am here
2		Power on	Massage starts
3		Shut down	Massage ends
4	Pause	Pause massage	Massage paused
5		Resume massage	Massage resumed
6		Continue massage	
7	Heat	Heating on	Heating on
8		Heating off	Heating off
9	Timer	5 Minutes	Massage will stop in 5 minutes
10		10 Minutes	Massage will stop in 10 minutes
11		15 Minutes	Massage will stop in 15 minutes

12	Timer	20 Minutes	Massage will stop in 20 minutes
13		25 Minutes	Massage will stop in 25 minutes
14		30 Minutes	Massage will stop in 30 minutes
15	Zero Gravity	Zero gravity 1	Zero gravity 1
16		Zero gravity 2	Zero gravity 2
17		Zero gravity 3	Zero gravity 3
18		Zero gravity	Zero Gravity mode 2
19		Back up	Back up
20		Back down	Back down
21		Back stop	Back stop
22		Leg up	Leg up
23		Leg down	Leg down
24		Leg stop	Leg stop
25	Foot Roller	Foot rolling	Foot rolling is on
26		Stop rolling	Foot rolling stop
27	Anion	Anion on	Anion is on
28		Anion off	Anion is off
29	Work Relief	Work relief mode	Work relief mode is on
30	Deep tissue	Deep tissue mode	Deep tissue mode is on

Items	Function	Order	Response
31	Thai	Thai mode	Thai stretch mode is on
32		Stretch mode	
33	Athletic	Athletic mode	Athletic mode is on
34	Vertebral	Vertebral mode	Vertebral mode is on
35	Neck and Shoulder	Neck and Shoulder mode	Neck and Shoulder mode is on
36	Recovery	Recovery mode	Recovery mode is on
37	Rest and sleep	Rest and sleep mode	Rest and sleep mode is on
38	Gental	Gental mode	Gental mode is on
39	For Her	For Her mode	For her mode is on
40		Beauty mode	
41	For Him	For Him mode	For him mode is on
42	Waist and Hip	Waist and Hip mode	Waist and hip mode is on
43	Manual	Manual mode	Manual mode is on
44		More roller strength	Strength increased
45		Less roller strength	Strength decreased
46		More air intensity	Air intensity increased
47		Less air intensity	Air intensity decreased



# Product Operation Guide

## End Operation

Please press the “ON/OFF” button after use, and the chair will stop its operation, while the massage rollers will return to their original position; then switch the power supply button under the chair to “O” and unplug the machine from the electrical outlet.

**⚠ Warning:** Supervision and guidance are necessary when disable, people who have obstacles in sense or spiritual, who are inexperienced in using it and who are lacking of the knowledge of it use the massage chair (including children). Unless there is someone who in charge of their safety, the massage chair is unavailable for them. Please take care of your children and make sure the chair not is played by them. There is heat function for the chair and should be cautions by those who insensitivity of heat.

## Product Features

OGAWA massage Chair is controlled by a microcomputer that performs various intelligent massage methods and combinations, like Kneading, Swedish, Tapping, Shiatsu, Clapping, Rolling, Footroller and Air Massage. All these massage methods accurately capture the acupressure points that could alleviate fatigue, promote metabolism and improve blood circulation effectively. Equipped with eight of full body automatic program, this product thoroughly fulfills your various needs.

Various types of manual / auto massage to suit your needs.

Spring-styled massage that is specially structured for the back is designed according to the curve of the human body to provide a more effective and thorough massage.

1. Designed according to body curve, to provide better massage sensations.
2. The Timer Function can be adjusted according to your desired duration of the massage programmer.
3. Liquid Crystal Display controller for a user friendly operation.
4. Built in with power surge and automatic temperature sensor for safety.
5. The operation is controlled by an intelligent microprocessor for excellent performance and consistent quality.
6. The machine radiates heat on the surface, Do Not use it over sensitive skin areas or in poorly-ventilated areas.

# Cleaning And Maintenance

## Cleaning of the synthetic leather

Wipe the synthetic leather with a soft dry cloth.

- **Do not clean the product with chemicals such as thinners, gasoline and alcohol.**
- **When using a leather maintenance product (cleaning cloth) sold on the market, follow its directions for use.**
- **If the synthetic leather is very dirty, wipe it with the method below.**
  1. Put a piece of soft cloth into water or 3% to 5% neutral detergent contained hot water and wring it out.
  2. Wipe surface of the synthetic leather with the soft cloth.
  3. Wipe the detergent with a piece of cloth once soaked in clean water and wrung out.
  4. Wipe with a piece of wrung soft cloth.
  5. Have the synthetic leather take natural air drying.
- **If it is difficult to remove the stains on the synthetic leather, soak a piece of melamine foam bought from the market into a neutral detergent and use it wipe the product.**
- **Do not dry the surface by a hair drier.**
- **Surface of the synthetic leather may be dyed by fabric colors; therefore, be careful when wiping the product with denim or colored cloth.**
- **Keep these positions from long-time contact with plastics to avoid fading.**
- **Synthetic leather may discolor, so the position in contact with the hair dye used should be covered by a towel.**

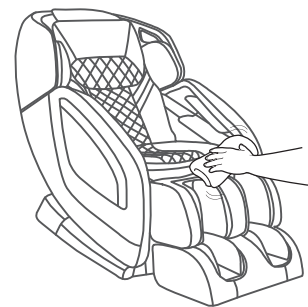

## Cleaning of the plastic parts

**1** Put a piece of soft cloth into water or neutral detergent contained hot water, wring it out and wipe the plastic parts.

- Do not clean the product with chemicals such as thinners, gasoline and alcohol.

**2** Wipe with a piece of cloth once soaked in clean water and wrung out.

- Wring the cloth out before using it to wipe the remote controller.

**3** Have the plastic parts take natural air drying.

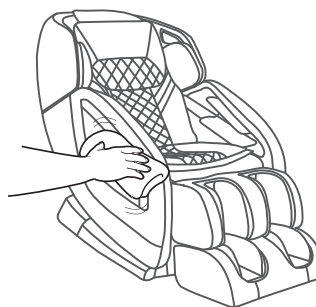

## Questions and answers Q&A )

**Q** Can persons paying frequent visits to hospitals because of diseases use the product?

**A** **These persons should consult physicians before using the product.**  
 Massage is the so-called "touch-pressure stimulation": Muscles are compressed to relieve their tension and promote hemokinesis. Some diseases may get worsened because of massage. Thus, consult the attending doctors before using the product.

**Q** How about the body height requirement for use of the product?

**A** **The body height requirement differs with the specific body type. See the rough reference below when using the product.**  
 If a person shorter than 145 centimeters or taller than 185 centimeters uses the upper body massage function and the Lower Leg/Foot massage function of the product at the same time, it will be possible that his soles will have poor contact with the foot massage section or that his knees will need to be bent.

For a taller person with knee bending when using the product:

Select method **A**

**A** Tilt the backrest and lower the Lower Leg/Foot massage section.



For a short person difficult to touch the foot massage section:

Select method **A**

**A** Raise the backrest and lift the Lower Leg/Foot massage section.

**Q** Are there any things needing special attention during moving?

**A** **Pay attention to the following things during moving.**  
 For convenience during moving, tilt backrest of the product till the lowest position.  
 During handling, do not sit on the product.

- ① Press ON button power on the product.
- ② Press  to make the backrest completely tilt.  
 Press and hold on these two buttons until backrest and footrest stop 
- ③ Turn off the power switch and pull out the power plug.

- If the original packing box is unavailable, make sure the power line is not wound on the product, wind it and place it on the seat surface. When handling the product, keep the power line from falling off and rubbing with ground.
- If the original packing box is unavailable, properly keep other packing auxiliary materials and wrap the product with them to avoid scratch and vibration during handling.

**Q** Where is serial number of the product?

**A** It is on back of the main body.

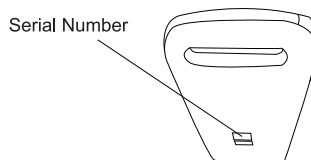

**Q** I care about the sounds the product makes when being used.

**A** It is caused by the core structure.

**Q** Does it matter if the massage wheels have different massage intensities?

**A** **This phenomenon possibly exists during massage because of the core structure.**  
 To simulate the most natural massage effect, the product is designed with a core structure allowing alternate back massage by a left massage wheel and a right massage wheel. During massage, the massage wheels possibly have slightly different positions on the back. That's why you have that feeling. It is not a fault.



**Q** The acupressure force is too large.

**A** **Set the air bag intensity to be "1" through the Air Bag button. You can also lower the Lower Leg/Foot massage section to reduce the acupressure force on the feet.**

# Troubleshooting

**After a fault happens, inspect and try the corresponding method below.**

If the fault still exists after that, contact the shop from which you bought the product.

Fault	Cause and elimination method
<p><b>The massage wheels stop during use</b> (The product beeps and all icons and buttons on the remote controller flicker and then go out.)</p>	<p><b>For safety, the massage wheels will possibly stop upon a too large external force during use.</b> If all marks and buttons on the remote controller begin to flicker, it suggests an extreme abnormality. In this case, turn off the power switch and turn it on about 10 seconds later. If the massage wheels stop again, adjust your sitting posture and do not lean on the backrest completely. (Users, particularly those heavier than 100 kilograms, should follow relevant precautions.)</p>
<p><b>The product cannot tilt, or the footrest cannot be raised or lowered</b> (The product beeps, the running light on the remote controller goes out and the product stops)</p>	<p><b>For safety, the product will stop upon an obstruction or a too large force.</b> If all contents and buttons are flickering and the backrest or the footrest has stopped, turn off the power supply and turn it on about 10 seconds later and then operate the product.</p>
<p><b>The massage wheels cannot reach the shoulders or the neck</b></p>	<p>If the head is not in contact with the headrest, or the back is not in contact with the backrest, the shoulder position in body type detection will possibly be lower than the actual position. Sit in the deepest position of the product, lean your head on the headrest and operate from the beginning again.</p>
<p><b>The left and right massage wheels have different heights (intensities)</b></p>	<p>It is not a fault but a normal phenomenon because the product is provided with a massage core allowing alternate beats of the massage wheels.</p>
<p><b>The product cannot run at all.</b> ● Upper body (the neck to the waist) massage ● Lower leg/foot massage</p>	<ul style="list-style-type: none"> <li>● The power line is disconnected.</li> <li>● The power switch is not turned on.</li> <li>● No program is selected after  on the remote controller is pressed.</li> </ul>
<p><b>No warm feeling in knee.</b></p>	<ul style="list-style-type: none"> <li>● The heating button is set to be OFF.</li> <li>● The warm feeling depends on factors such as body type, massage method, clothes and room temperature. Make the knee in close contact, the warm transfer part is in close contact with the knee to make you feel warm. You may cover your knees with a blanket to get warmer.</li> </ul>
<p><b>The product cannot cool down even if the heating function is disabled.</b></p>	<ul style="list-style-type: none"> <li>● Due to the heater structure, the product will still feel warm shortly after heating because of the residual heat.</li> <li>● If a single part is continually massaged even after the heating function is disabled, you will feel increasingly warmer.</li> </ul>
<p><b>The power supply cannot be connected even if  is pressed again after the massage</b></p>	<ul style="list-style-type: none"> <li>● The program will terminate about 5 seconds after the massage has ended. Press  at least 5 seconds after all the movements have stopped.</li> </ul>
<p><b>The product is damaged</b></p>	
<p><b>The power line or the power plug has abnormal heating</b></p>	<p>To avoid accidents, contact an authorized service center.</p>

# Troubleshooting

## The sounds and feelings you care about in use of the product

**You will hear or have the following sounds or feelings when using the product. It is not abnormal phenomena but results of the product structure.**

- Sound when the stretching massages are retracted
- Sound and feeling when the massage wheels rub patterns on the fabric
- Sound of movements such as kneading and beat
- Friction sound of the running massage wheels
- Sound of up-down movement
- Sound of the conveyor belt
- Motor sound
- Sound of the squeezing massage wheels when they begin to stretch
- Sound when a person is sitting on the seat
- Friction sound between the armrests and the back cushion when the backrest is tilting
- Friction sound between the massage wheels and the fabric
- Sound of the inflator pump during Air Bag massage
- Sound of air exhaust during Air Bag massage
- Running sound of the solenoid valve at bottom of the product during Air Bag massage.
- Swing of the footrest
- Sound when the shoulders are stretched or moved
- Running sound of the air bags
- Sliding sound of the foot massage section
- Friction sound between the back cushion and the back cover leather when the backrest is tilting

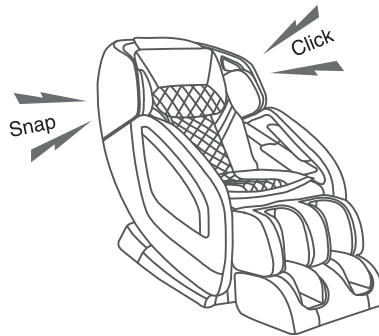

**If the sound is loud, it is also possible that the product has failed.**

- In this case, have the product inspected and repaired by an authorized service center.

### **Warning**

- **Do not refit, disassemble or repair the product without permission.** Otherwise fires, abnormal movements or personal injuries may happen.

### **Warning**

- **In the case of any abnormality or fault, stop the product immediately and pull out the power plug to avoid fuming, fires and electric shocks.**  
< Abnormality and fault examples >
  - The product fails to work after the power switch is turned to the ON position;
  - After the power line is moved, the product is discontinuously powered on;
  - In use, the product gives off a burning smell or an abnormal sound;
  - The product is deformed or abnormally heating→ In any of these abnormalities and faults, have the product inspected and repaired by an authorized service center immediately.

## Product Specifications

Power supply		AC220-240V~,50/60Hz
Power consumption		150W
Upper body massage	Range of massage (up-down direction)	Approx. 97cm
	Massage speed	Kneading:Approx.21 times/min-Approx.37 times/min
		Beat:Approx.422 times/min-Approx. 703 times/min
		Moving speed:Approx.43mm/s
Power consumption		Backrest: Approx. 124°~157° Footrest: Approx. 92.5°~ 115°
Automatic power-off		Approx. 15 minutes(automatic power-off)
Dimension	When it is not tilting (H x W x L)	Approx. 1520mm x 750mm x 1175mm
	When it is tilting (H x W x L)	Approx. 1935mm x 750mm x 1025 mm
Weight		Approx. 73 Kg
Dimensions of packing box (H x W x L)		Seat rest: 1420x820x1235mm Footrest: 530x440x510mm
Weight(including the packing box)		Approx. 90 Kg
Operating Conditions		Ambient temperature:Approx.0°C~35°C Relative humidity:Approx.20%~80%
Storage Conditions		Ambient temperature:Approx.-5°C~35°C Relative humidity:Approx.20%~80%
Maximum body weight of user		Approx. 120Kg

For a user heavier than 100 kilograms, the product may have bigger noise and its fabric housing may be worn quicker.

## Contact Us



**MALAYSIA**  
Healthy World Lifestyle Sdn Bhd  
No. 22 Jalan Anggerik Mokara 31/47  
Kota Kemuning, 40460 Shah Alam  
Selangor Darul Ehsan, Malaysia  
Tel : +603-5121 4286  
Fax: +603-5121 4386



**HONG KONG, CHINA**  
OGAWA Health Care International (HK) Ltd  
31/F,YHC Tower,1Sheung Yuet Road  
Kowloon Bay  
Kowloon  
Hong Kong  
Tel:+852 3465 6262  
Fax:+852 2410 0119



**SINGAPORE**  
OGAWA Health-Care Pte Ltd  
27 Tampines Industrial Avenue 5,  
T5 @ Tampines  
Singapore 528623  
  
Tel:+065-6846 8588  
Fax:+065-6846 7677



**VIETNAM**  
OGAWA Vietnam Co Ltd  
2nd floor,Petroland Tower,  
12 Tan Trao,Tan Phu ward  
District 7, Ho Chi Minh  
Tel:+84 8 54133 222/54133 223  
Fax:+84 8 5416 1736



**PHILIPPINES**  
O-Healthcare Solution Phil. Inc.  
2303, 4th Floor, G&A Building,  
Chino Roces Avenue Extension,  
Makati City, Philippines  
Tel : +632 889 0676 / + 632 844 6851  
Fax: +632 812 0421

Ogawa is grateful  
to have received  
these awards:



Ogawa Wellness Hubs : Malaysia . Singapore . Vietnam . Philippines . Indonesia . Myanmar . India . China .  
Hong Kong . Taiwan . Turkey . Pakistan . Mauritius . Russia . France . Canada . Thailand .  
Korea . Australia . Dubai . K.S.A . Nigeria . Egypt . Lebanon . Denmark . Sweden . U.S.A